



IMPROVING FARM PRODUCTIVITY

# PRODUCT RANGE





## **SUMO: A NAME RICH IN TRADITION AND SYNONYMOUS WITH STRENGTH AND POWER.**

Our machines are built to this same mantra. With extensive farming experience behind them, our design and production team create products that are built to last. Choose to buy a Sumo UK machine and you'll be investing in a long term, cost-effective solution to establish your crops without detriment to the yield. Our dedicated customer service and support team ensure you are not only buying a machine but a farming partner.

# CONTENTS

<b>4 - 5</b>	Mounted Trio	<b>24 - 25</b>	Strake
<b>6 - 7</b>	Trailed Trio	<b>26 - 27</b>	DTS
<b>8 - 9</b>	Quatro	<b>28 - 29</b>	DD
<b>10 - 11</b>	Vaxio	<b>30 - 31</b>	DTS and DD Toolbars
<b>12 - 13</b>	Multipress	<b>32 - 33</b>	Front Hopper & Multipacka
<b>14 - 15</b>	Mixidisc	<b>34 - 35</b>	Options and Extras & Front Weight
<b>16 - 17</b>	LDS	<b>36 - 37</b>	LMD & Trailing Kit
<b>18 - 19</b>	GLS	<b>38 - 39</b>	Sumoseeder & SDO
<b>20 - 21</b>	Subsoiler	<b>40 - 41</b>	Packer Options
<b>22 - 23</b>	Rippa	<b>42 - 43</b>	Wearing Metal Options

# MOUNTED TRIO

One-pass seed bed preparation. The Trio alleviates sub-surface compaction and mixes stubble and soil, leaving a level surface ready for seeding.

<b>PRODUCT SPECIFICATIONS</b>	<b>TRIO 2.5</b> S/P	<b>TRIO 2.5</b> A/R	<b>TRIO 3</b> S/P	<b>TRIO 3</b> A/R	<b>TRIO 3.5</b> A/R
Code	TR2.5SP	TR2.5AR	TR3SP	TR3AR	TR3.5AR(7)
Working Width	2.4m	2.4m	2.9m	2.9m	3.4m
Transport Width	2.55m	2.55m	3.0m	3.0m	3.5m
Subsoiler Leg	5	5	6	6	7
Leg Spacing	500mm	500mm	500mm	500mm	500mm
Maximum Leg Depth	400mm	400mm	400mm	400mm	400mm
Discs	18	18	22	22	24
Disc Depth	30-100mm	30-100mm	30-100mm	30-100mm	30-100mm
Disc Adjustment	Manual	Manual	Manual	Manual	Manual
Type	Rigid	Rigid	Rigid	Rigid	Rigid
Weight	2468kg	2515kg	2795kg	2855kg	3070kg



120 - 300



2.5M - 3.5M



400MM

● MOUNTED TRIO 3M SHOWN HERE



- + Tungsten-tipped points make for significantly reduced downtime
- + 760mm Sumo Multipacka roller with shouldered rings and drive lugs
- + Ultra-low draught subsoiler legs mounted in a staggered pattern for excellent trash flow
- + Disc unit can be removed
- + Double row of 500mm concave discs mounted in pairs to prevent disc stalling

### TRIO OPTIONS

	SEEDER FITTING KIT	TRIO 3M & 3.5M TRAILING KIT	FRONT DISCS FOR TRIO TRAILING KIT
Code	MTSFK	TKIT	FDTKIT

### PACKER OPTIONS

Available		MULTIPACKA	DIAMOND
		✓	✓

# TRAILED TRIO

One-pass seed bed preparation. The Trio alleviates sub-surface compaction and mixes stubble and soil, leaving a level surface ready for seeding.

<b>PRODUCT SPECIFICATIONS</b>	<b>TRAILED TRIO 3 A/R</b>	<b>TRAILED TRIO 3.5 A/R</b>	<b>TRAILED TRIO 4.5 A/R</b>	<b>TRAILED TRIO 5.5 A/R</b>	<b>TRAILED TRIO 6.5 A/R</b>
Code	TTR3AR	TTR3.5AR	TRF4.5AR	TRF5.5AR	TRF6.5AR
Working Width	3.0m	3.5m	4.5m	5.5m	6.5m
Transport Width	3.25m	3.75m	2.9m	2.9m	2.9m
Subsoiler Leg	6	6	9	11	13
Leg Spacing	500mm	583mm	500mm	500mm	500mm
Maximum Leg Depth	400mm	400mm	400mm	400mm	400mm
Discs	23	28	34	42	52
Disc Depth	30-100mm	30-100mm	30-100mm	30-100mm	30-100mm
Disc Adjustment	Manual	Manual	Manual	Manual	Manual
Type	Rigid	Rigid	Hydraulic Folding	Hydraulic Folding	Hydraulic Folding
Tyre Size	480/45-17	480/45-17	600/50-22.5	600/50-22.5	600/50-22.5
Weight	4220kg (4745kg with front discs)	4706kg (5300kg with front discs)	8631kg	9101kg	10025kg



175 - 600



3M - 6.5M



400MM

● TRAILED RIGID TRIO 3M SHOWN HERE.



- + Tungsten-tipped points make for significantly reduced downtime
- + Sumo Multipacka roller 800mm with shouldered rings
- + Folded trio features front depth adjustment via shims on the drawbar ram
- + Ultra-low draught subsoiler legs
- + Double row of 500mm concave discs mounted in pairs to prevent disc stalling
- + Disc unit can be removed

### TRAILED TRIO OPTIONS

	OPTIONAL 3M FRONT DISCS	OPTIONAL 3.5M FRONT DISCS	RIGID SEEDER FITTING KIT	FOLDING SEEDER FITTING KIT	REAR DRAWBAR*	3RD HYDRAULIC SERVICE TO REAR DRAWBAR*	AIR BRAKE KIT
Code	FD3	FD3.5	TTRSFK	TRFSFK	TRFRD	TRF3SK	TRFABK

### PACKER OPTIONS

	MULTIPACKA	DIAMOND
Available	✓	✓

\*Folded machines only.

# QUATRO

Versatile, one-pass, minimum tillage cultivator with four elements that can be fine-tuned to adapt to a variety of conditions.

<b>PRODUCT SPECIFICATION</b>	<b>TRAILED QUATRO 3</b>	<b>TRAILED QUATRO 4</b>	<b>TRAILED QUATRO 5</b>	<b>TRAILED QUATRO 6</b>
Code	Q3	Q4	Q5	Q6
Working Width	3.0m	4.0m	5.0m	6.0m
Transport Width	3.25m	3.0m	3.0m	3.0m
Subsoiler Leg	6	8	10	12
Leg Spacing	500mm	500mm	500mm	500mm
Maximum Leg Depth	400mm	400mm	400mm	400mm
Discs	48	64	80	96
Disc Depth	30-100mm	30-100mm	30-100mm	30-100mm
Disc Adjustment	Hydraulic adjustable	Hydraulic adjustable	Hydraulic adjustable	Hydraulic adjustable
Type	Rigid	Hydraulic folding	Hydraulic folding	Hydraulic folding
Tyre Size	480/45-17	600/50-22.5	710/45-26.5	710/45-26.5
Weight	5930kg	10210kg	11965kg	12958kg





180 - 600



3M - 6M



400MM

● QUATRO 5M SHOWN HERE.

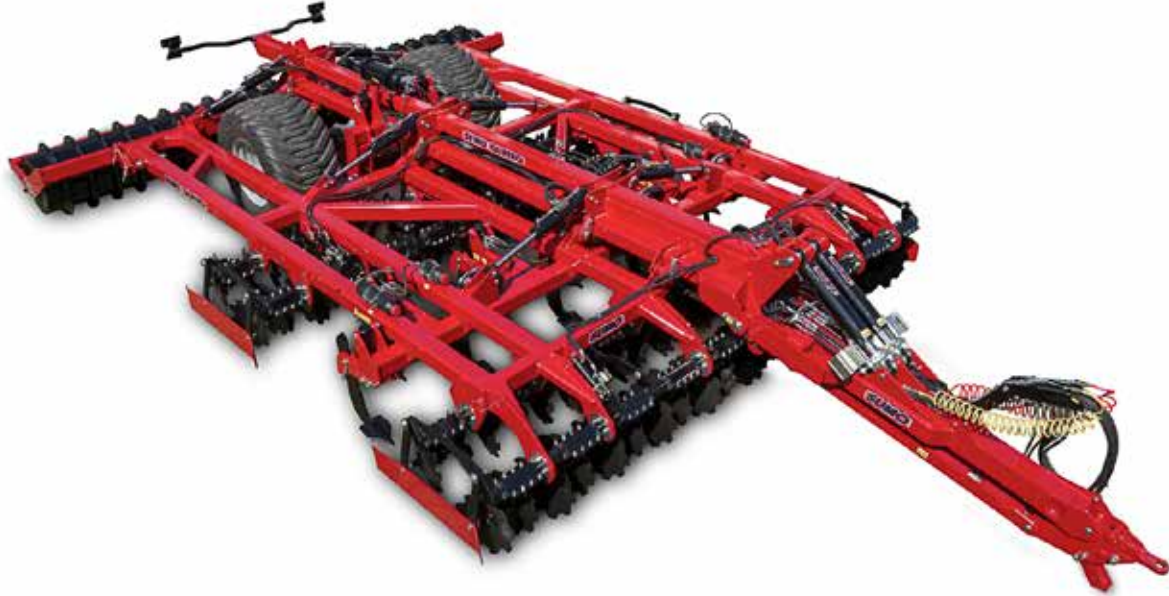

Sumo Multipacka roller 800mm with shouldered rings



Hydraulic auto-reset, ultra-low draught subsoiler legs



Each element of the Quatro is adjustable, allowing the user to fine-tune the machine to suit local conditions



Tungsten-tipped points make for significantly reduced downtime, with a maximum working depth of up to 400mm

### QUATRO OPTIONS

	REAR DRAWBAR	3RD HYDRAULIC SERVICE TO REAR DRAWBAR	SEEDER FITTING KIT	AIR BRAKE KIT
Code	QRD	Q3SK	QSFK	QABK

### PACKER OPTIONS

Available			MULTIPACKA	DIAMOND
			✓	✓

# VAXIO

High-speed and versatile cultivator which combines surface cultivation and loosening to a depth with even levelling and consolidation in one pass.

<b>PRODUCT SPECIFICATION</b>	<b>TRAILED VAXIO 4</b>	<b>TRAILED VAXIO 5</b>	<b>TRAILED VAXIO 6</b>
Code	V4	V5	V6
Working Width	4.0m	5.0m	6.0m
Transport Width	3.0m	3.0m	3.0m
Subsoiler Leg	13	16	20
Leg Spacing	300mm	300mm	300mm
Maximum Leg Depth	250mm	250mm	250mm
Discs	32	40	48
Disc Depth	30-100mm	30-100mm	30-100mm
Disc Adjustment	Hydraulic adjustable	Hydraulic adjustable	Hydraulic adjustable
Type	Hydraulic folding	Hydraulic folding	Hydraulic folding
Weight	7380kg	8352kg	9224kg
Roller - Multipacka Standard			



240 - 600



4M - 6M



250MM

VAXIO 6M SHOWN HERE.



- + Deep loosening legs at 300mm spacing will work to 250mm deep
- + Proven 20-inch double drive leading cultivation discs
- + Multipacka Standard / Diamond Roller option
- + Row of adjustable levelling paddles
- + Quick change point auto-reset
- + Hydraulic folding
- + Heavy-duty spring-loaded auto reset tines

### PACKER OPTIONS

Available

MULTIPACKA

DIAMOND



## Seen Something you like?

Contact your local dealer for details or visit: [www.sumo1.com](http://www.sumo1.com) to find out more

# MULTIPRESS

The Multipress is a versatile machine for tilling, levelling and pressing on a wide variety of conditions.

<b>PRODUCT SPECIFICATION</b>	<b>MOUNTED MULTIPRESS 3</b>	<b>TRAILED MULTIPRESS 5</b>	<b>TRAILED MULTIPRESS 6</b>
Code	MUL3	MUL5	MUL6
Working Width	3.0m	5.0m	6.0m
Transport Width	3.0m	2.8m	2.8m
Tines	10	16	20
Tine Spacing	300mm	300mm	300mm
Tine Depth	25-250mm	25-250mm	25-250mm
Type	Rigid	Hydraulic Folding	Hydraulic Folding
Hydraulic Brake	No	Yes	Yes
Tyre Size	-	600/50-22.5	600/50-22.5
Weight	2440kg	6950kg	7770kg



100 - 450



3M - 6M



250MM

MULTIPRESS 5M SHOWN HERE.



Standard 310mm wide points. Optional narrow 60mm points available



Heavy duty, spring-loaded auto-reset tines



Hydraulically-adjustable levelling paddles



Hydraulic folding

### PACKER OPTIONS

MULTIPACKA

SHARP

CHANNEL

ROLLER

Available



## Seen Something you like?

Contact your local dealer for details or visit: [www.sumo1.com](http://www.sumo1.com) to find out more

# MIXIDISC / S

The Mixidisc is a high-speed multipurpose cultivator for tilling, levelling and incorporating large volumes of crop residue.

<b>PRODUCT SPECIFICATION</b>	<b>MOUNTED MIXIDISC / S3</b>	<b>MOUNTED MIXIDISC / S4</b>	<b>TRAILED MIXIDISC / S5</b>	<b>TRAILED MIXIDISC / S6</b>	<b>TRAILED MIXIDISC / S7</b>
Code	MIX3	MIX4	TMIX5	TMIX6	TMIX7
Working Width	3.0m	4.0m	5.0m	6.0m	7.0m
Transport Width	3.0m	2.8m	3.0m	3.0m	3.0m
Number of Discs	24	32	40	48	56
Discs Diameter	500mm	500mm	500mm	500mm	500mm
Disc Depth	30-100mm	30-100mm	30-100mm	30-100mm	30-100mm
Disc Adjustment	Manual	Manual	Manual	Manual	Manual
Type	Rigid	Hydraulic folding	Hydraulic folding	Hydraulic folding	Hydraulic folding
Tyre Size	-	-	600/50-22.5	600/50-22.5	600/50-22.5
Weight	2010kg	3220kg	6860kg	7985kg	9005kg



100 - 500



3M - 7M



100MM  
(DISC)

● TRAILED MIXIDISC 6M SHOWN HERE.



- + Working depth between 30mm–140mm with 20mm increment adjustment
- + Sumo Multipacka roller 800mm with shouldered rings standard
- + Suspended 500mm discs mounted on maintenance-free bearings
- + Soil retainers as standard
- + Hydraulic folding

### MIXIDISC OPTIONS

	SEEDER FITTING KIT RIGID FOR 3M	SEEDER FITTING KIT FOR 4M	SEEDER FITTING KIT FOR 5M/6M/7M	REAR DRAWBAR*	3RD HYDRAULIC SERVICE REAR DRAWBAR*	WHEEL ERADICATORS*	AIR BRAKE KIT
Code	MIXRSFK	MIXFSFK	TMSFK	TMRD	TMHS	TMWE	TMABK

### PACKER OPTIONS

	MULTIPACKA	DIAMOND
Available	✓	✓

\*Folded machines only.

# LDS

The Sumo Low Disturbance Subsoiler (LDS) alleviates compaction with minimal surface disturbance.

<b>PRODUCT SPECIFICATION</b>	<b>MOUNTED LDS 3 F</b>	<b>MOUNTED LDS 3 R</b>	<b>MOUNTED LDS 3 M</b>	<b>MOUNTED LDS 4 F</b>	<b>MOUNTED LDS 4 R</b>	<b>MOUNTED LDS 4 M</b>
Code	LDS3FAR	LDS3RAR	LDS3MAR	LDS4FAR	LDS4RAR	LDS4MAR
Working Width	3.0m	3.0m	3.0m	4.0m	4.0m	4.0m
Transport Width	3.1m	3.1m	3.1m	2.9m	2.9m	2.9m
Subsoiler Leg	6	6	6	8	8	8
Leg Spacing	500mm	500mm	500mm	500mm	500mm	500mm
Packer Type	Flat	Rings	Multipacka	Flat	Rings	Multipacka
Disc Diameter	500mm	500mm	500mm	500mm	500mm	500mm
Type	Rigid	Rigid	Rigid	Hydraulic folding	Hydraulic folding	Hydraulic folding
Weight	2170kg	2450kg	2450kg	3085kg	3315kg	3315kg

<b>PRODUCT SPECIFICATION</b>	<b>MOUNTED LDS 5 F</b>	<b>MOUNTED LDS 5 R</b>	<b>MOUNTED LDS 5 M</b>	<b>TRAILED LDS 5M</b>	<b>TRAILED LDS 6M</b>
Code	LDS5FAR	LDS5RAR	LDS5MAR	LDS5TM	LDS6TM
Working Width		5.0m	5.0m	5.0m	6.0m
Transport Width		2.9m	2.9m	2.9m	2.9m
Subsoiler Leg		10	10	10	12
Leg Spacing		500mm	500mm	500mm	500mm
Packer Type		Flat	Rings	Multipacka	Multipacka
Disc Diameter		500mm	500mm	500mm	500mm
Type		Hydraulic folding	Hydraulic folding	Hydraulic folding	Hydraulic folding
Tyre Size		-	-	-	600/50-22.5
Weight		3645kg	3990kg	3990kg	11150kg





130 - 450



3M - 6M



350MM

MOUNTED LDS 4M



+ Two loosening leg options

+ Pin-adjustable low disturbance loosening legs (100-350mm working depth)

+ 500mm leg spacing

+ Combine with the Sumoseeder for cost effective, fuel-saving sowing of oilseed rape directly into stubble

### LDS OPTIONS

	TRAILED SEEDER FITTING KIT	MOUNTED RIGID SEEDER FITTING KIT	MOUNTED FOLDING SEEDER FITTING KIT
Code	TRFSFK	LDSRSFK	LDSFSFK

### PACKER OPTIONS

	MULTIPACKA	DIAMOND	TYRE	FLAT	RINGS
Available	✓	✓	✓	✓	✓

# GLS

The Sumo Grassland Subsoiler (GLS) improves and revitalises compacted grassland that is suffering from the effects of continual heavy machinery, livestock and rainfall.

<b>PRODUCT SPECIFICATION</b>	<b>MOUNTED GLS 3-LEG A/R</b>	<b>MOUNTED GLS 4-LEG A/R</b>	<b>MOUNTED GLS 5-LEG A/R</b>
Code	GLS3AR	GLS4AR	GLS5AR
Working Width	2.3m	2.3m	2.8m
Transport Width	2.5m	2.5m	2.9m
Subsoiler Leg	3	4	5
Leg Spacing	833mm	580mm	580mm
Leg Depth	100-350mm	100-350mm	100-350mm
Type	Rigid	Rigid	Rigid
Weight	1490kg	1625kg	1875kg
Roller	Flat	Flat	Flat



100 - 250



2.3M - 2.8M



300MM

● GLS 4 LEG SHOWN HERE.



- + Flat packer, leaving an aerated, consolidated and level finish
- + Pin adjustable depth control from 100-350mm
- + Optional following harrow
- + Narrow wing points for low surface disturbance
- + Leading row of straight serrated discs mounted on individually suspended arms
- + Adjustable depth position via a one-bolt system
- + Low draught auto-reset legs

### GLS OPTIONS

	FOLLOWING HARROW 3&4 LEG*	FOLLOWING HARROW 5 LEG*	SEEDER FITTING KIT
Code	FH4	FH5	GLSSFK

### PACKER OPTIONS

Available	FLAT	✓
-----------	------	---

\*WHEN ORDERED WITH MACHINE.

# SUBSOILER

The Sumo Subsoiler is a heavy duty, robust machine which enables the loosening and consolidation of compact soil conditions.

PRODUCT SPECIFICATION	MOUNTED S/P SUBSOILER 3	MOUNTED A/R SUBSOILER 3	MOUNTED S/P SUBSOILER 4	MOUNTED A/R SUBSOILER 4	MOUNTED S/P SUBSOILER 5	MOUNTED A/R SUBSOILER 5
Code	S3SP	S3AR	S4SP	S4AR	S5SP	S5AR
Working width	2.7m	2.7m	2.8m	2.8m	3.4m	3.4m
Transport width	3.0m	3.0m	3.0m	3.0m	3.6m	3.6m
Subsoiler leg	3	3	4	4	5	5
Leg spacing	900mm	900mm	650mm	650mm	650mm	650mm
Leg depth	0-500mm	0-500mm	0-500mm	0-500mm	0-500mm	0-500mm
Type	Rigid	Rigid	Rigid	Rigid	Rigid	Rigid
Weight	2200kg	2480kg	2360kg	2575kg	3000kg	3250kg

PRODUCT SPECIFICATION	TRAILED S/P SUBSOILER 7	TRAILED A/R SUBSOILER 7	TRAILED S/P SUBSOILER 9	TRAILED A/R SUBSOILER 9
Code	SF7SP	SF7AR	SF9SP	SF9AR
Working width	4.7m	4.7m	5.9m	5.9m
Transport width	2.9m	2.9m	2.9m	2.9m
Subsoiler leg	7	7	9	9
Leg spacing	650mm	650mm	650mm	650mm
Leg depth	0-500mm	0-500mm	0-500mm	0-500mm
Type	Hydraulic folding	Hydraulic folding	Hydraulic folding	Hydraulic folding
Tyre Size	600/50-22.5	600/50-22.5	600/50-22.5	600/50-22.5
Weight	7204kg	8014kg	8248kg	8818kg



150 - 600



2.7M - 5.9M



500MM

● MOUNTED SUBSOILER 4 LEG SHOWN HERE.



Multi-shear pin or hydraulic auto-reset protection



V-shape frame for added strength and aids trash flow



Maximum depth 500mm



Single bolt to replace the point assembly



Pin-depth adjustment

### SUBSOILER OPTIONS

	SEEDER FITTING KIT TRAILED	SEEDER FITTING KIT MOUNTED	STRAIGHT LEADING DISC EACH (28.5KG)*
Code	SFSFK	SSFK	SLDTS

### PACKER OPTIONS

Available		MULTIPACKA	DIAMOND
		✓	✓

# RIPPA

The Sumo Rippa is a heavy-duty deep cultivation tool to rip up the land, aiding aeration of the soil.

<b>PRODUCT SPECIFICATION</b>	<b>MOUNTED RIPPA 3M</b>	<b>MOUNTED RIPPA 4F</b>	<b>MOUNTED RIPPA 6M</b> Folding
Code	R3	R4F	R6F
Working Width	3.0m	4.0m	6.0m
Transport Width	3.0m	3.0m	3.0m
Legs	11	15	23
Leg spacing	270mm	270mm	270mm
Leg depth	400mm	400mm	400mm
Leg length	700mm	700mm	700mm
Type	Rigid	Hydraulic folding	Hydraulic folding
Weight	1425kg	2820kg	3240kg



120 - 600



3M - 6M



400MM

● RIPPA 3M SHOWN HERE.



+ Resin-filled puncture proof-tyres

+ Shear-bolt protection

+ Working depth up to 400mm

+ Reversible 80mm wide points

## Seen something you like?

Contact your local dealer for details or visit: [www.sumo1.com](http://www.sumo1.com) to find out more.

# STRAKE

The Sumo Strake is a high-speed straw rake used for creating a stale seed bed. An essential machine for effective use of minimum tilling and direct drilling.

<b>PRODUCT SPECIFICATION</b>	<b>MOUNTED STRAKE 6</b>	<b>MOUNTED STRAKE 8</b>	<b>TRAILED STRAKE 12</b>
Code	S6	S8	S12
Working width	6.1m	8.1m	12.1m
Transport width	2.5m	3.0m	3.0m
Tines	80	107	160
Tine spacing	75mm or 150mm	75mm or 150mm	75mm or 150mm
Type	Hydraulic folding	Hydraulic folding	Hydraulic folding
Tyre Size	-	-	560/45 22.5
Weight	2435kg	3100kg	7950kg





125 - 400



6.1M - 12.1M

● MOUNTED STRAKE 8M SHOWN HERE.



- + Retractable alternate rows of tines for working in heavy or damp straw
- + 75mm or 150mm tine spacing
- + Reduces slug population by mixing crop residue with soil
- + 15mm tungsten carbide tips fitted to heavy duty spring tines
- + Even distribution of harvest residue
- + Hydraulically adjustable tine angle

## Need help?

A member of our support team can assist you. Simply email [info@sumo1.com](mailto:info@sumo1.com) with any questions and we'll get back to you as soon as we can.

# DTS

The Sumo Deep Tillage Seeder (DTS) is an exceptionally versatile drilling system, giving the user the option to direct drill into stubble, minimum tillage or plough-based systems.

PRODUCT SPECIFICATION	MOUNTED DTS 3	TRAILED DTS 4	TRAILED DTS 5	TRAILED DTS 6	TRAILED DTS 8	TRAILED DTS 9
Code	DTS3	DTS4	DTS5	DTS6	DTS8	DTS9
Working Width	3.0m	4.0m	5.0m	6.0m	8.0m	9.0m
Transport Width	3.0m	2.8m	2.8m	2.8m	2.9m	2.9m
Total Hopper Capacity (litres)	1900	3000	3000	3600	3600	3600
Row Spacing (mm)	333	333	333	333	333	346
Rows	9	12	15	18	24	26
Half Width Shut Off	No	No	No	Yes	Yes	Yes
Double Seed Row	Standard	Standard	Standard	Standard	Standard	Standard
Seed Row Width (mm)	120mm	120mm	120mm	120mm	120mm	120mm
Loosening Legs	9	12	15	18	24	26
Loosening Leg Spacing (mm)	333	333	333	333	333	346
Roller	Tyre	Tyre	Tyre	Tyre	Tyre	Tyre
Camera	2	2	2	2	2	2
Lights	Standard	Standard	Standard	Standard	Standard	Standard
Markers	Optional	Optional	Optional	Optional	-	-
Type	Mounted	Trailed	Trailed	Trailed	Trailed	Trailed
Tyre Size	-	560/45-22.5	560/45-22.5	620/40-22.5	710/35-22.5	710/35-22.5
Weight	3280kg	6600kg	8061kg	9550kg	11135kg	12673kg



150 - 600



3M - 9M



250MM

● MOUNTED DTS 3M SHOWN HERE.



- Sumo Orga metering with optional variable seed rate drilling
- 15mm tungsten carbide tips fitted to heavy duty spring tines
- Grain and fertiliser option\*
- Cameras and LED work lights
- Hydraulic brakes\*
- Covering discs ensure seed to soil contact
- GPS compatible
- Even seed placement

### DTS OPTIONS

	AIR BRAKE KIT	HYDRAULIC PARK STAND	MARKERS (UP TO 6M ONLY)	TRAMLINES GRAIN ONLY	GRAIN & FERT OPTION (4M & 5M)*	GRAIN & FERT OPTION (6M, 8M & 9M)*	TRAMLINES G&F	DTS MOUNTED WEIGHT TRANSFER KIT	OPTIONAL VARIABLE SEED RATE DRILLING
Code	DTSABK	DTSHPS	DTSDM	DTSTGO	DTSGF45	DTSGF689	DTSTGF	DTSWT	SWB1075

\*Trailed machines only.

# DD

The Sumo Direct Drill (DD) is the essential tool for zero-till crop establishment where seed placement is required with minimal soil disturbance.

<b>PRODUCT SPECIFICATION</b>	<b>MOUNTED DD 3</b>	<b>TRAILED DD 4</b>	<b>TRAILED DD 5</b>	<b>TRAILED DD 6</b>	<b>TRAILED DD 8</b>	<b>TRAILED DD 9</b>
Code	DD3	DD4	DD5	DD6	DD8	DD9
Working Width	3.0m	4.0m	5.0m	6.0m	8.0m	9.0m
Transport Width	3.0m	2.8m	2.8m	2.9m	2.9m	2.9m
Total Hopper Capacity (litres)	1900	3000	3000	3600	3600	3600
Row Spacing (mm)	187.5	200	208	200	200	200
Rows	16	20	24	30	40	45
Half Width Shut Off	No	No	No	Yes	Yes	Yes
Double Seed Row	Standard	Standard	Standard	Standard	Standard	Standard
Seed Row Width (mm)	187.5	200	208	200	200	200
Camera	2	2	2	2	2	2
Lights	Standard	Standard	Standard	Standard	Standard	Standard
Markers	Optional	Optional	Optional	Optional	Not available	Not available
Type	Mounted	Trailed	Trailed	Trailed	Trailed	Trailed
Tyre Size	-	560/45-22.5	560/45-22.5	620/40-22.5	710/35-22.5	710/35-22.5
Weight	2700kg	6785kg	7797kg	9050kg	10330kg	11448kg



120 - 500



3M - 9M

● TRAILED DD 6M SHOWN HERE.



- + Sumo Orga metering with optional variable seed rate drilling
- + Cameras and LED work lights
- + GPS compatible
- + Trailing angled covering wheels
- + Hydraulic brakes\*
- + Even seed placement
- + Grain and fertiliser option\*
- + Seed flaps ensure seed-to-soil contact and prevent seed bounce
- + Independent contour-following coulters

### DTS OPTIONS

	AIR BRAKE KIT	HYDRAULIC PARK STAND	MARKERS (UP TO 6M ONLY)	TRAMLINES GRAIN ONLY	GRAIN & FERT OPTION (4M & 5M)	GRAIN & FERT OPTION (6M, 8M & 9M)	TRAMLINES G&F	DTS MOUNTED WEIGHT TRANSFER KIT	OPTIONAL VARIABLE SEED RATE DRILLING
Code	DTSABK	DTSHPS	DTSDM	DTSTGO	DTSGF45	DTSGF689	DTSTGF	DTSWT	SWB1075

\*Trailed machines only.

# TOOLBAR SYSTEMS

The Sumo Toolbar systems have been developed to provide the user with a flexible solution to their crop establishment needs.

<b>PRODUCT SPECIFICATION</b>	<b>DTS 3 TOOLBAR</b>	<b>DTS 4 TOOLBAR</b>	<b>DD 3 TOOLBAR</b>	<b>DD 4 TOOLBAR</b>
Code	DTS3T	DTS4TF	DD3T	DD4T
Working Width	3.0m	4.0m	3.0m	4.0m
Transport Width	3.0m	2.8m	3.0m	2.8m
Row Spacing (mm)	333	333	187.5	200
Rows	9	12	16	20
Type	Rigid	Hydraulic folding	Rigid	Hydraulic folding
Weight	2890kg	3995kg	2670kg	3920kg

- Full road lighting kit
- Independent contour following coulters
- Even seed placement
- Optional variable rate drilling
- Paired with Sumo Front Hopper making the ideal drilling system



150 - 350



3M - 4M



250MM



120 - 280



3M - 4M



For more information on the DTS Toolbar see pages 26 - 27. Also see Front Hopper on page 32.



For more information on the DTS Toolbar see pages 28 - 29. Also see Front Hopper on page 32.

**TOOLBAR OPTIONS**

	DTS TOOLBAR WEIGHT TRANSFER	DTS HYDRAULIC MARKERS	DTS TRAMLINES 2 ROWS (MOUNTED)	DD TOOLBAR WEIGHT TRANSFER	DD HYDRAULIC MARKERS	DD TRAMLINES 2 ROWS (MOUNTED)	OPTIONAL VARIABLE SEED RATE DRILLING
Code	DTSTWT	DTSTM	DTSTT	DDTWT	DDTM	DDTT	SWB1075

# FRONT HOPPER

The Sumo Front Hopper complements any rear-mounted implement.



- + Sumo Orga metering system with optional variable seed rate drilling
- + Tank light
- + GPS compatible
- + Hydraulic fan
- + Satellite speed sensor
- + Cat 2 linkage
- + One touch calibration

PRODUCT SPECIFICATION	FRONT HOPPER ONLY	SIDE TRANSFER PIPE	UPSTACK (12 X38MM OUTLETS)	TRAMLINE SHUT OFF (PAIR)
Code	FH	FHTPT	FHU	FHTSO
Capacity (litres)	1900	-	-	-
Seed Rate	1-350kg	-	-	-
Lights	Yes	-	-	-
Weight	850kg	-	-	-



# MULTIPACKA

The Sumo Front Multipacka is the perfect addition to your conventional cultivation and drilling system



100 - 200



3M - 4M



NO LEGS

- + Option of front-leading tines (as shown) or hydraulically-operated levelling paddles
- + 800mm roller with scrapers
- + Water ballast packer roller if extra weight is required
- + Steering headstock

PRODUCT SPECIFICATION	FRONT MULTIPACKA 3M	FRONT MULTIPACKA 4M RIGID	FRONT MULTIPACKA 4M FOLDING	3M LEVELLING PADDLES	4M LEVELLING PADDLES	SINGLE RIGID TINE ASSEMBLY
Code	FM3T	FM4T	FM4F	FMPA	FMPA4	FMSTA
Type	Rigid	Rigid	Hydraulic folding	Hydraulic folding	Hydraulic folding	Hydraulic folding
Weight	1350kg	1590kg	2150kg	1570kg	2464kg	1550kg



# OPTIONS & EXTRAS

# FRONT WEIGHT

The Sumo Front Weight is the ideal multifunctional addition to your tractor



- + Toolbox included with removable tool tray
- + Towing point as standard
- + Lockable lid
- + High visibility stickers
- + LED marker lights
- + Maximises pulling power

PRODUCT SPECIFICATION	FRONT WEIGHT 1000KG	FRONT WEIGHT 1500KG	FRONT WEIGHT 2000KG	FRONT WEIGHT 2500KG	ALTERNATIVE COLOUR
Code	FW1	FW1.5	FW2	FW2.5	FWAC

# L M D

The Sumo Linkage Mounted Drawbar (LMD) increases the manoeuvrability of trailed machines. Perfect for both Sumo and non-Sumo products.



- + Hydraulic bulk head
- + Cat 3 & 4 three-point linkage
- + Optional hydraulic service extensions
- + Ball hitch
- + Park stands
- + Rated to 400 Horsepower max
- + Seven-pin lighting plug adaptor

## PRODUCT SPECIFICATION

	LMD	SPOON COUPLING (TT/QUAT/MIXI/MULTI ETC)	SPOON COUPLING (DD/DTS)	SPOON COUPLING (WELD ON)
Code	TMLMD	SWB186	SW3201	SW811

# TRAILING KIT

The Sumo Trailing Kit is to fit pre-2012 models of the Mounted Trio, transforming it into a trailed machine.



**Bring your old Trio back to life with the Sumo Trailing Kit.**

## TRAILING KIT OPTIONS

Code

TRIO 3M & 3.5M  
TRAILING KIT

TKIT

FRONT DISCS FOR  
TRIO TRAILING KIT

FDTKIT

# SUMOSEEDER

The Sumoseeder is the perfect addition to your cultivator.



- + 180 litre hopper capacity
- + Fan status and low -evel product alarms
- + Forward speed display
- + Twin electric fans
- + Area meter
- + Adjustable seed outlets for band or full width sowing
- + Sumo Orga metering system
- + GPS speed controlled

## PRODUCT SPECIFICATION

	STANDARD 6 OUTLET SEEDER (NO FITTING KIT)	ADDITIONAL OUTLET (MAX.12)
Code	SS	SSOK
Seed Rate Range	1-30kg/ha*	-
Weight	80kg (including pallet)	-

\* BASED ON A 3M 6-ROW MACHINE.

# SDO

The Sumo Single Disc Opener (SDO) is a great way to enhance your cultivation machine, ideal for drilling oilseed rape at an accurate and consistent depth.



- + Rubber suspension mounts
- + Slim line tungsten-edged opener
- + 450mm hardened disc angled in 2 planes
- + Folds for transport
- + Quality sealed bearings on disc and press-wheels
- + Multi-adjustable pins for sowing depth control and down-force

## PRODUCT SPECIFICATION

PRODUCT SPECIFICATION	SINGLE UNIT SDO
Code	SDO
Weight	47kg

# PACKER OPTIONS

The Sumo modular ring packer can be fitted to your Sumo machine, providing the user with a selection of ring options to suit a variety working conditions.

- Bolt-on segments allows ease of replacement and options to change
- Spoked design to allow soil to flow ensuring a good levelling effect

## CHOOSE FROM MULTIPLE RING OPTIONS:

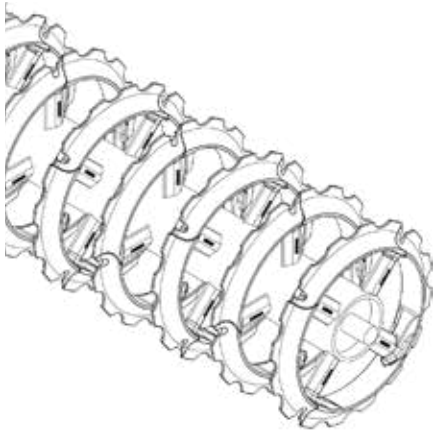

### SHARP

Suitable for heavy soils to slice and crack clods

**SPACING: 250MM**

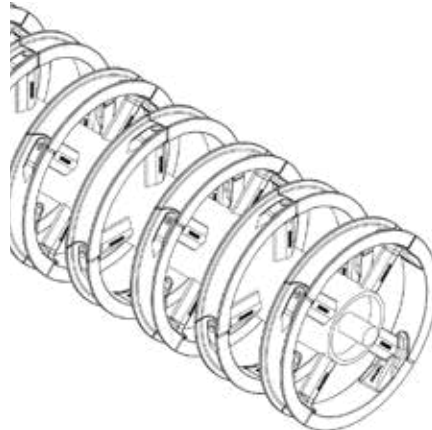

### CHANNEL

Suitable for shallow cultivating and soil to soil consolidation

**SPACING: 250MM**



### ROLLER

Suitable for intensive consolidation on varying soil types

**SPACING: 250MM**



## DIAMOND

Maximum consolidation to depth whilst leaving a weatherproof finish.

**SPACING: 220MM**

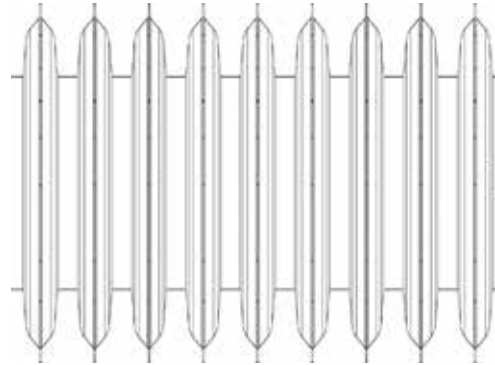
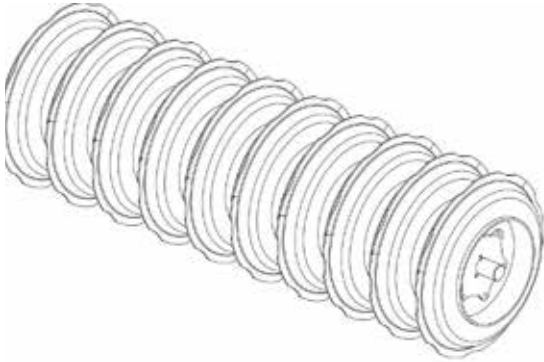

## TYRE

Concentrated consolidation across the full width of the machine.

**SPACING: DEPENDENT ON MACHINE.**

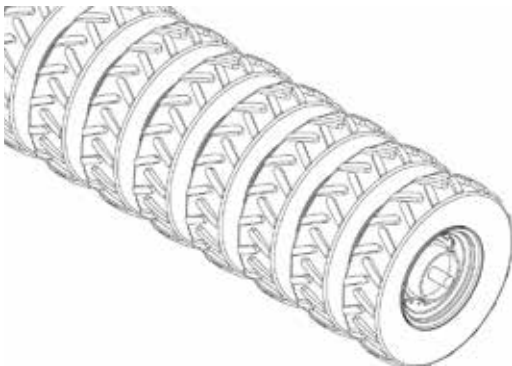

## MULTIPACKA

Versatile option, providing even consolidation of soil.

**SPACING: 250MM**

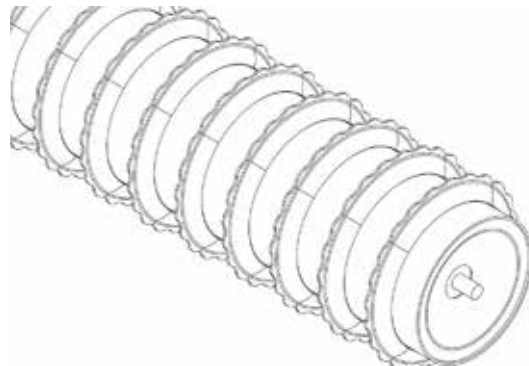

# WEARING METAL OPTIONS

## DTS TINE & LEG

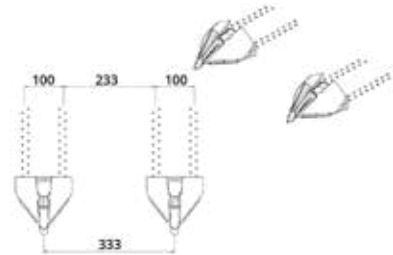
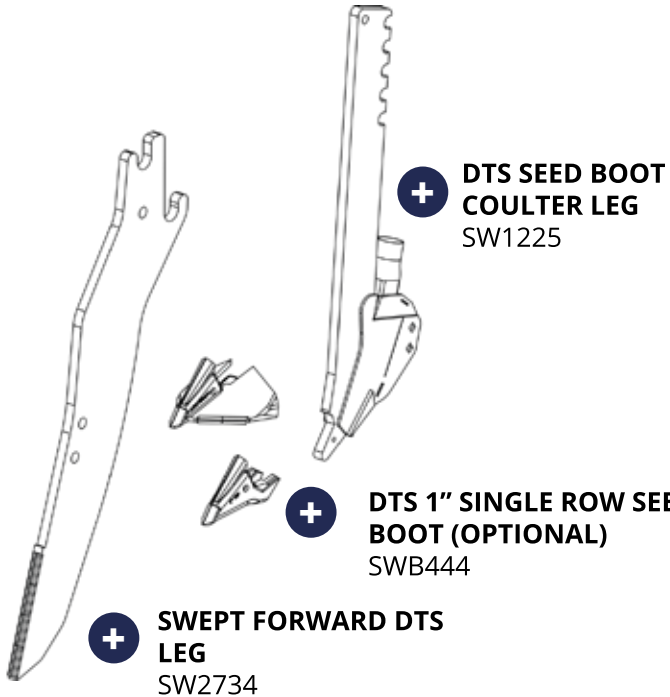

**+ DTS 5" DOUBLE ROW SEED BOOT (STANDARD)**  
SWB443

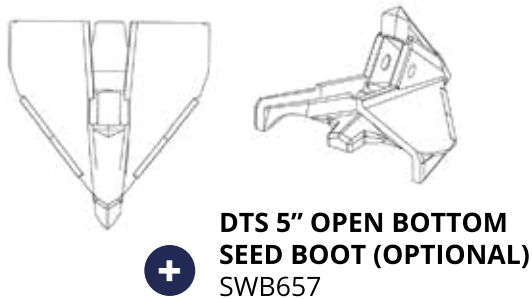

## DD PARTS

**DD/DTS OPENER DISC**  
SWB442 **+**

**DD BOTTOM CAST COULTER (RH)**  
SWB488 **+**

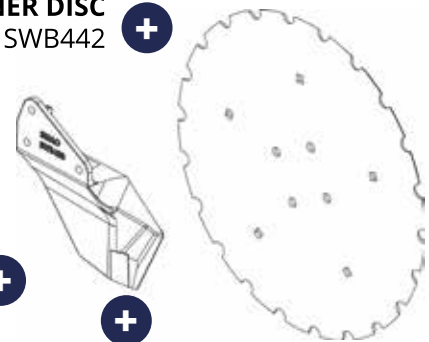

**+ DD BOTTOM CAST COULTER (LH)**  
SWB490

# WEARING METAL OPTIONS

## ARABLE LEG

**SHIN**  
SW1048

**4" WING**  
SWB401

**STANDARD  
CONCORD  
POINT**  
SW1050

**TRIO LEG**  
SW1046

- Full Trio / Quatro leg (SW1046) is optional on GLS. All points also optional (SWB441, SWB401, SW1050) when SW1046 is used on GLS.

**8" WING**  
SWB366

**LOW DISTURBANCE  
POINT**  
SWB441

## LOW DISTURBANCE LEG

**GLS LEG**  
SW1151

**GLS POINT**  
SW1087

- Standard Trio / Quatro point
- Standard LDS point
- Optional for LDS
- Optional for Trio / Quatro



IMPROVING FARM PRODUCTIVITY

SUMO UK LTD.  
REDGATES, MELBOURNE, YORK  
YO42 4RG. UNITED KINGDOM

+44 (0) 1759 319900

SALES@SUMO1.COM

WWW.SUMO1.COM



REG NO. 03272544